

Barkbusters

www.barkbusters.net

FITTING INSTRUCTIONS for VPS-MX

FITTING INSTRUCTIONS

1. Install aluminium clamp to the handlebar in preferred position (see Diagram 1)
2. Assemble handguard as per Diagram 2.

NOTE: The black plastic bracket can be fitted in two positions, A or B. Choose the setup that best suits your bike (see diagram 2).

NOTE: Left and right markings for correct side fitting.

Caution: Do not over tighten the two screws (8) that secure the plastic bracket to the back of the plastic handguard.

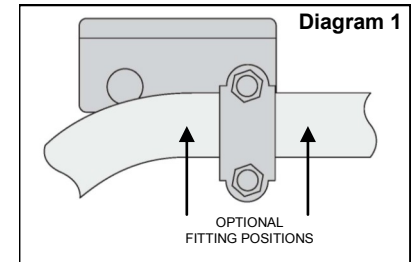
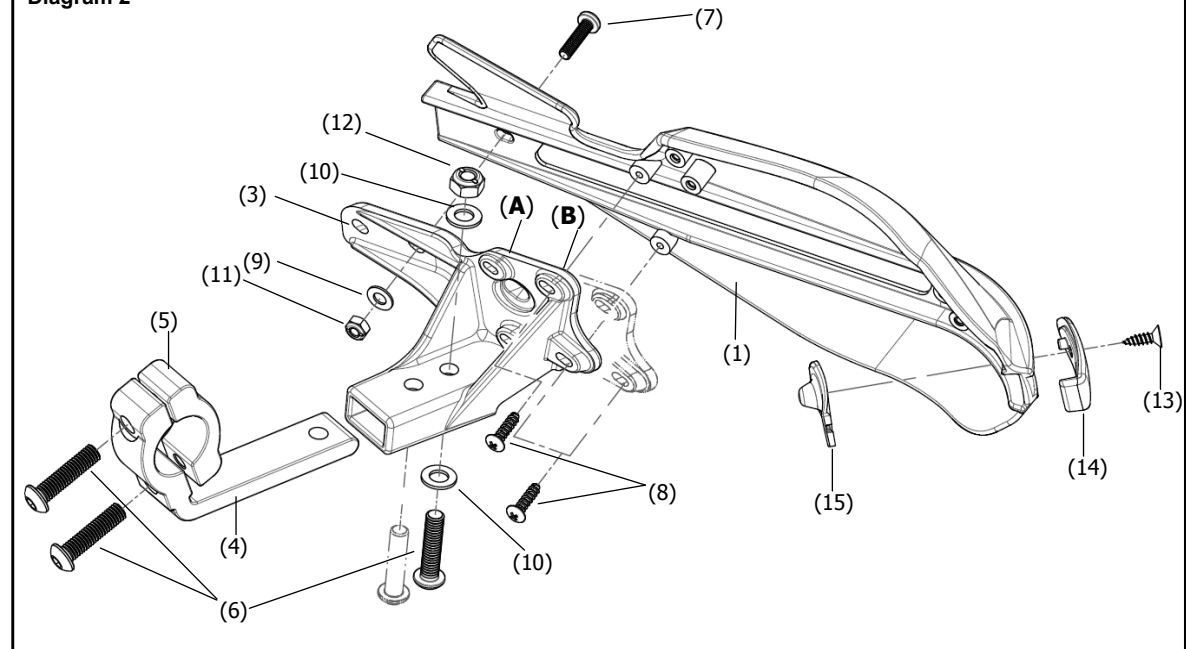















Diagram 2



1 VPS Plastics  PN: BVPS Pcs. 1 Left & 1 Right	2 L-Bracket Left  PN: VPS-MX-L Pcs. 1	3 L-Bracket Right  PN: VPS-MX-R Pcs. 1	4 Clamp Frame  PN: MPE-007-17 Pcs. 2	5 Clamp Saddle  PN: MPE-008-17 Pcs. 2	6 Button Head Bolt  PN: M6x25BHCSZP Pcs. 6	7 Mush Head Bolt  PN: M4x16MHBB Pcs. 2	8 Screw  PN: SCREWPT3.5x14 Pcs. 4
9 Washer 4mm  PN: M4FW Pcs. 2	10 Washer 6mm  PN: M6FW Pcs. 4	11 Nylock Nut 4mm  PN: M4LN Pcs. 2	12 Nylock Nut 6mm  PN: M6LN Pcs. 2	13 Self Tapping Screw  PN: ST6G12CP Pcs. 2	14 Hole Cover Plate  PN: BHG7-PK-CP Pcs. 1 Left & 1 Right	15 Back Retaining Plate  PN: BHG7-PK-RP Pcs. 1 Left & 1 Right	

Recommended Torque Settings	
M6	10 Nm (7.4 lbf ft)
M8	20 Nm (14.8 lbf ft)

CAUTION:

Installation of the handguard is safety-relevant work and can be complicated. We recommend the installation be performed by a motorcycle service technician. Rideworx accepts no liability for damages caused by improper mounting. All screws, bolts and nuts, including all replacement hardware provided by Rideworx, should be tightened to the torque specified in the table. After the first 50km of riding check all screws, bolts and nuts are tightened to the correct torque. We recommend a medium strength liquid thread lock product on all fasteners.

WARNING:

Check operation of all handlebar controls, specifically the throttle, front brake, kill switch and clutch to ensure they are operating correctly and are in accordance with the OEM specifications. Do not ride the motorcycle if any controls are not operating correctly. Check periodically that all bolts are tight.



Phone: +61 (0)2 4271 8244
 Email: info@barkbusters.net
 Web: www.barkbusters.net



Disclaimer:

A failure to follow these fitting instructions could cause serious injury, death or property damage. These handguards are intended solely for use with motorcycles/ATV/snowmobiles/scooters that have not been modified. They are not designed to prevent injury or death while riding or in an accident or crash. The user must ensure that all controls are free of the handguards every time that they ride. By installing and/or using this product you acknowledge that you accept these terms and have followed the fitting instructions.