

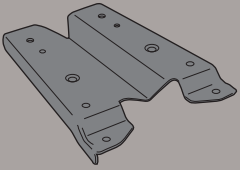

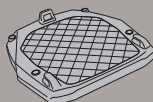

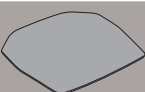





SR7703 - KR7703

PORTAPACCO SPECIFICO - SPECIFIC HOLDER - PORTE-PAQUET SPÉCIFIQUE - SPEZIFISCHER TRÄGER - PORTA-EQUIPAJE ESPECÍFICO - TRANSPORTADOR ESPECÍFICO

KTM 1190 ADVENTURE R (2013)

N°	Descrizione	Caratteristiche	Codice	Quantità	
1	Supporto - Support - Support Halierung - Soporte - Apoio	Sp. 3mm	GL2384	1	
2	Piastra - Plate Platine - Platte Parrilla - Grelha	-	Z4400	1	
3	Copripiastra - Cover Plate Couvre Platine - Abdeckplatte Cubre Parrilla - Placa De Cobre	-	Z4401	1	
4	Vite - Screw Vis - Schraube Tornillo - Parafuso	TEF M8x70	870TEF	2	
5	Vite - Screw Vis - Schraube Tornillo - Parafuso	TCEI M6x25	625TCE	4	
6	Vite - Screw Vis - Schraube Tornillo - Parafuso	TSCEI M8x65	865TSP	2	
7	Vite - Screw Vis - Schraube Tornillo - Parafuso	-	VP3X16PG	2	
8	Distanziale - Spacer Entretoise - Distanzstueck Distanciador - Espaçador	Ø18x25 Foro 10,5mm	V667	2	
9	Distanziale - Spacer Entretoise - Distanzstueck Distanciador - Espaçador	Ø18x30 Foro 9,5mm	V793	2	
10	Piastrina - Little Plate Petite Plaque - Plaettchen Plaqueta - Plaqueta	-	GN522	4	
11	Rondella - Washer Rondelle - Scheibe Arandela - Arruela	Ø6	6RON	4	
12	Dado - Bolt - Ecro Mutter - Tuerca - Porca	Auto Bloccante Flangiato M6	6DADIAFLN	4	

SR7703 - KR7703

PORTAPACCO SPECIFICO - SPECIFIC HOLDER - PORTE-PAQUET SPÉCIFIQUE - SPEZIFISCHER TRÄGER - PORTA-EQUIPAJE ESPECÍFICO - TRANSPORTADOR ESPECÍFICO

KTM 1190 ADVENTURE R (2013)

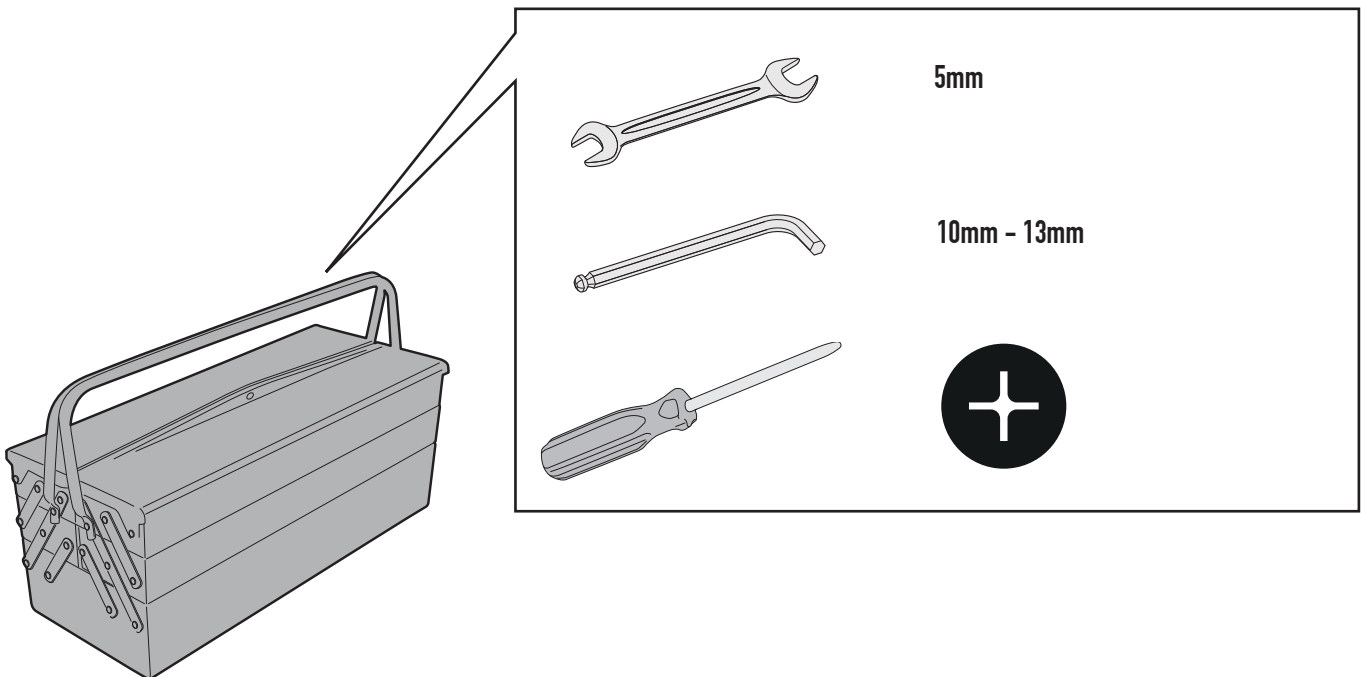

SR7703 - KR7703

PORTAPACCO SPECIFICO - SPECIFIC HOLDER - PORTE-PAQUET SPÉCIFIQUE - SPEZIFISCHER TRÄGER - PORTA-EQUIPAJE ESPECÍFICO - TRANSPORTADOR ESPECÍFICO

KTM 1190 ADVENTURE R (2013)

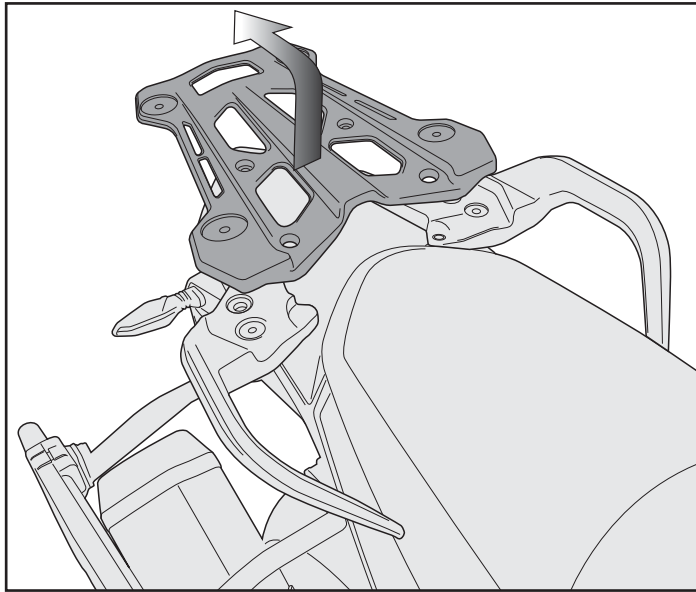

TOGLIERE

REMOVE

ENLEVER

ENTFERNEN

QUITAR

REMOVED

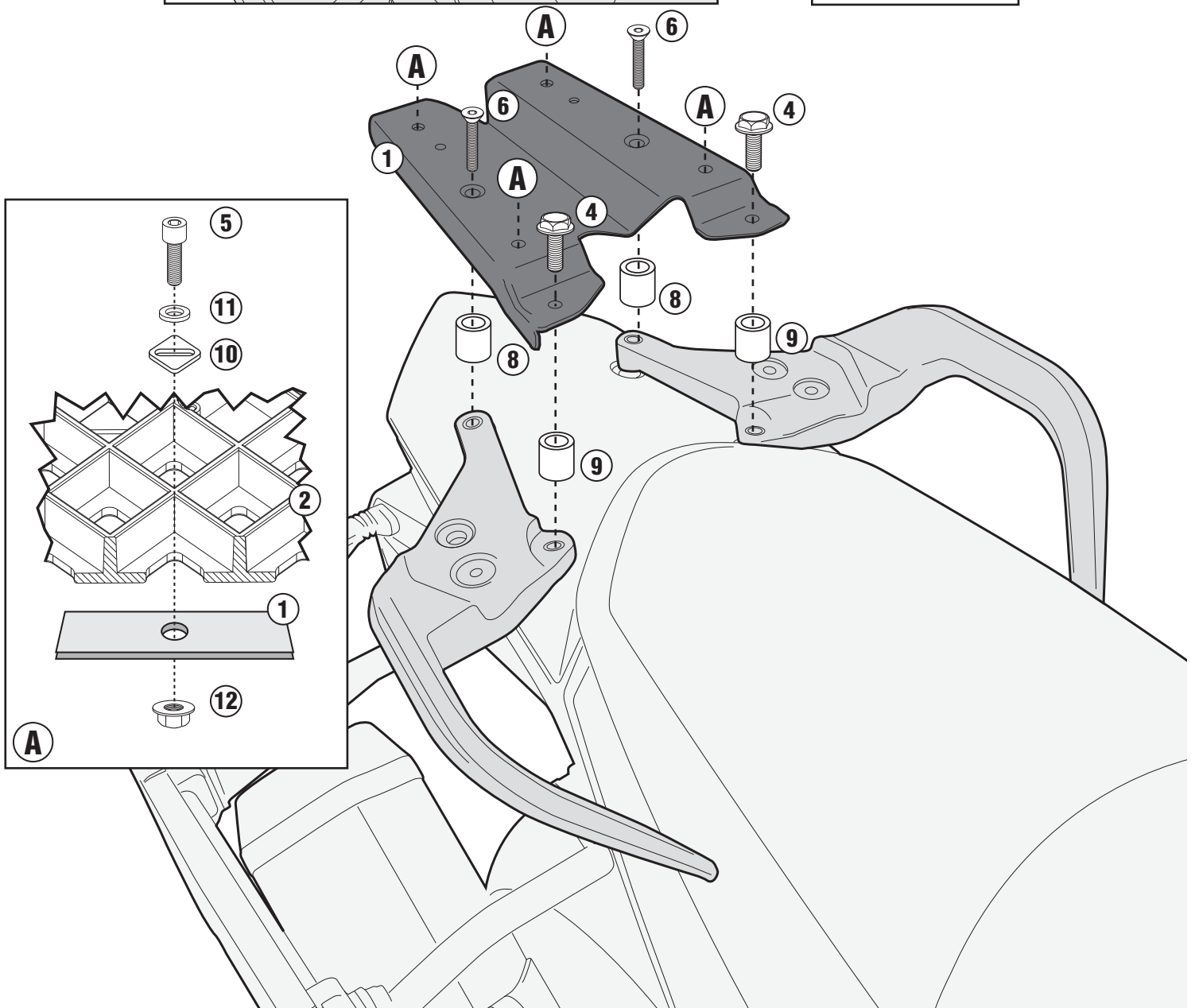

ISTRUZIONI DI MONTAGGIO - MOUNTING INSTRUCTIONS
INSTRUCTIONS DE MONTAGE - BAUANLEITUNG
INSTRUCCIONES DE MONTAJE - INSTRUÇÕES DE MONTAGEM